



# MAX3674 Evaluation Kit

## General Description

The MAX3674 evaluation kit (EV kit) is a fully assembled and tested demonstration board that simplifies evaluation of the MAX3674 high-performance dual-output network clock synthesizer. The EV kit includes a 16MHz crystal and other hardware components necessary to evaluate all the MAX3674 functions. Software is provided that communicates with the EV kit through a USB port. The software provides an easy way to set operational modes and read/write internal registers. The EV kit is powered by a +3.3V supply and USB port. SMA connectors are used for the reference clock input and LVPECL clock outputs to simplify connection to test equipment. Two LEDs indicate the status of LOCK and USB power.

## Features

- ◆ Fully Assembled and Tested
- ◆ On-Board 16MHz Crystal Reference
- ◆ Software Control Through USB Port
- ◆ SMA Connectors for Clock I/Os
- ◆ Powered by +3.3V Supply and USB Port
- ◆ Indicators for LOCK and USB Power

## Ordering Information

PART	TYPE
MAX3674EVKIT+	EV Kit

+Denotes lead-free/RoHS-compliant.

## Component List

DESIGNATION	QTY	DESCRIPTION
C1, C2	2	33pF ±10% ceramic capacitors (0402)
C3, C4	0	Not installed
C5, C18, C20, C21, C22, C24, C26, C28, C29, C31, C33	11	0.1µF ±10% ceramic capacitors (0603)
C6, C34	2	22µF ±10% ceramic capacitors (1206)
C7, C14, C41, C42	4	0.22µF ±10% ceramic capacitors (0402)
C8, C9, C11, C12, C13, C40, C47, C48	8	0.1µF ±10% ceramic capacitors (0402)
C10	1	0.01µF ±10% ceramic capacitor (0402)
C15, C16, C19, C32	4	4.7µF ±10% ceramic capacitors (0805)
C17, C23, C25, C27, C30	5	1µF ±10% ceramic capacitors (0603)
C35	1	0.01µF ±10% ceramic capacitor (0603)
D1, D2	2	LEDs, green Panasonic LN38GPX
J1	1	Mini USB connector, B type Tyco 1734035-1

DESIGNATION	QTY	DESCRIPTION
J5	1	2 x 3 pin header (0.1in centers) Sullins PEC36SAAN
J6, J7	2	Test points Keystone 5000
J10–J13	4	SMA connectors, edge-mount, tab center Johnson 142-0701-851
J17	1	SMA connector, PCB mount Johnson 142-0701-231
L1	1	22µH ±20% inductor, 520mA Taiyo-Yuden CBC3225T220M
L2	1	4.7µH ±20% inductor, 870mA Taiyo-Yuden CBC3225T4R7M
L4–L7	4	Ferrite beads Murata BLM18HK102SN1 (0603)
R1, R21	2	49.9Ω ±1% resistors (0603)
R2	1	10Ω ±1% resistor (0603)
R3	1	470Ω ±1% resistor (0603)
R4, R6–R11	7	4.75kΩ ±1% resistors (0603)
R5	1	1.5kΩ ±1% resistor (0603)
R12, R13, R22, R23	4	10kΩ ±1% resistors (0603)
R24	1	680Ω ±1% resistor (0603)
R25–R28	4	143Ω ±1% resistors (0603)
R34, R35	2	4.99kΩ ±1% resistors (0603)

Evaluates: MAX3674



# MAX3674 Evaluation Kit

## Component List (continued)

DESIGNATION	QTY	DESCRIPTION
TP1–TP7, TP10	8	Test points Keystone 5000
U1	1	High-performance dual-output network clock synthesizer (48 LQFP) Maxim MAX3674ECM+
U2	1	Microcontroller (28 SO) Microchip PIC16C745-I/SO
U3	1	Dual level translator (8 SOT23) Maxim MAX3373EEKA+
U4	1	I/O port expander (24 TQFN) Maxim MAX7312ATG+

DESIGNATION	QTY	DESCRIPTION
U5	1	Buffer (5 SC-70) Fairchild NC7SV125P5X
Y1	1	16.000MHz SMD crystal, 18pF Citizen HCM49-16.000MABJ-UT
Y2	1	6.000MHz SMD crystal, 32pF ECS ECS-60-32-5PXDN-TR
None	2	Shunts for J5 Sullins SSC02SYAN
None	1	PCB: MAX3674 EV Kit+ Circuit Board, Rev A

### Quick Start

**Note:** In the following sections, software-related items are identified by bolding. Text in bold refers to items directly from the EV kit software. Text in bold and underlined refers to items from the Windows® operating system.

- 1) Install two shunts on jumper J5, both to the (L) position. This sets address pins ADR0 and ADR1 low.
- 2) Connect a +3.3V supply to VCC (J6) and GND (J7). Set the supply current limit to 200mA.
- 3) Connect the computer to the EV kit with a USB cable (A-Male to Mini-B-Male). LED D2 should switch on, indicating that USB power is detected.
- 4) To download the latest version of the EV kit software (MAX3674revX.zip), visit the Maxim website at [www.maxim-ic.com/evkitsoftware](http://www.maxim-ic.com/evkitsoftware). Uncompress the zip file to a local folder and run the installation file (setup.exe). Installation requires administrative rights and may also require Internet access to download necessary drivers.
- 5) After installation is complete, follow this path to start the program: **Start** → **All Programs** → **Maxim Integrated Products** → **MAX3674 Evaluation Kit**
- 6) Press the **Initialize / Test Communication** button. The message box should report:
  - USB Device Detected**
  - MAX3674 Detected**
  - MAX7312 Detected**
- 7) Press the following buttons in this order: **RESET** → **LOAD** → **READ**. At this point, the LOCK output should be high (LED D1 on), indicating that the PLL is locked.
- 8) Set the values for **P**, **NA**, **NB**, and **M** to obtain the desired output frequency.
- 9) Press the **LOAD** button, followed by the **READ** button.
- 10) Connect the clock outputs (QA,  $\overline{QA}$ , QB,  $\overline{QB}$ ) to test equipment with SMA cables. Terminate unused outputs.

Windows is a registered trademark of Microsoft Corp.

# MAX3674 Evaluation Kit

Evaluates: MAX3674

## Detailed Description

The MAX3674 EV kit simplifies evaluation by providing the hardware and software needed to evaluate all the MAX3674 functions. A microcontroller (Microchip PIC16C745) and I/O port expander (MAX7312) allow the user to set control pins and read/write registers with software. The on-board 16MHz crystal and integrated oscillator generate the PLL reference clock. Alternatively, an external clock source can be connected to the REF\_CLK input to serve as the reference clock. LED D1 switches on when the LOCK output is high, indicating the PLL is locked.

The microcontroller is powered by the USB port +5V supply. LED D2 switches on when USB power is detected. The MAX3674 and I/O port expander are powered by the +3.3V supply. The EV kit also includes the MAX3373 level translator that interfaces the I<sup>2</sup>C clock and data lines from the microcontroller to the MAX3674 and I/O port expander, and is powered by both supplies. The USB cable and +3.3V supply can be connected to the EV kit in any sequence.

### Master Reset

It is recommended to press the **RESET** button after every power-up.

### LVPECL Clock Outputs

The LVPECL clock outputs (QA,  $\overline{QA}$ , QB,  $\overline{QB}$ ) have on-board bias-Ts that provide DC biasing and AC-couple the signal to allow direct connection to 50 $\Omega$ -terminated test equipment. Unused outputs should be terminated to prevent reflections on the transmission lines.

### Reference Clock Input

The REF\_CLK input (J17) accepts sinusoidal or square-wave clocks with frequencies between 15MHz and 20MHz, and swings up to 3.3V<sub>p-p</sub>. This input has a 50 $\Omega$  DC termination to ground and is AC-coupled to an on-board buffer. The buffer is used to square the clock signal applied to the REF\_CLK input pin.

### I<sup>2</sup>C Slave Address

Jumper J5 is used to set the two selectable address bits (ADR0 and ADR1). The EV kit software performs a search at power-up to determine which of the four possible slave addresses is being used.

### EV Kit Software

The EV kit software provides an easy way to set operational modes and read/write internal registers (Figure 1). Refer to the MAX3674 data sheet for detailed descriptions of the MAX3674 functions and guidance on selecting dividers settings. Note that when the **Programming Interface** is set to **I<sup>2</sup>C**, the settings for dividers **P**, **NA**, **NB**, and **M** are configured within the MAX3674 after pressing the **LOAD** button.

# MAX3674 Evaluation Kit

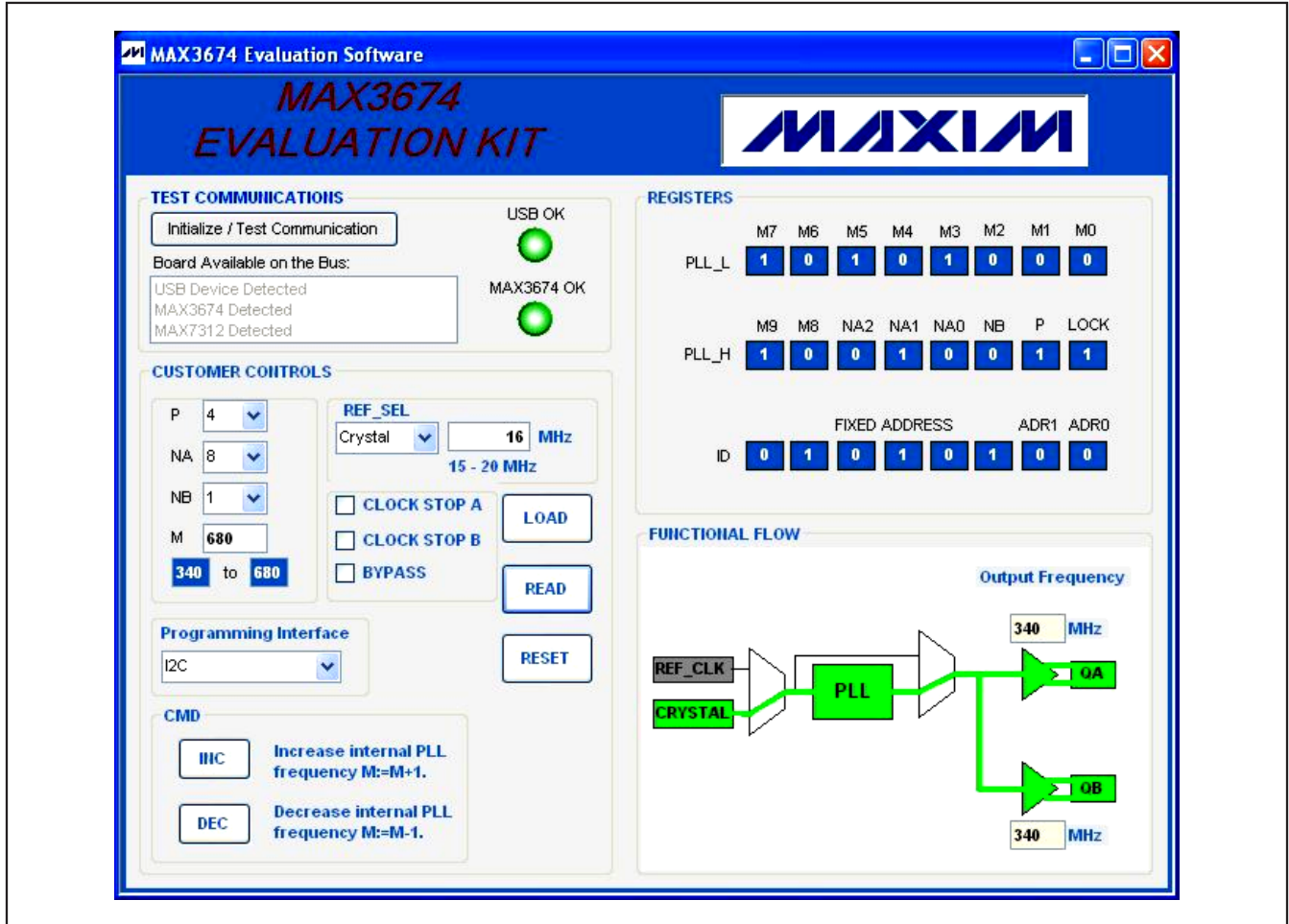

Figure 1. MAX3674 EV Kit Software

# MAX3674 Evaluation Kit

Evaluates: MAX3674

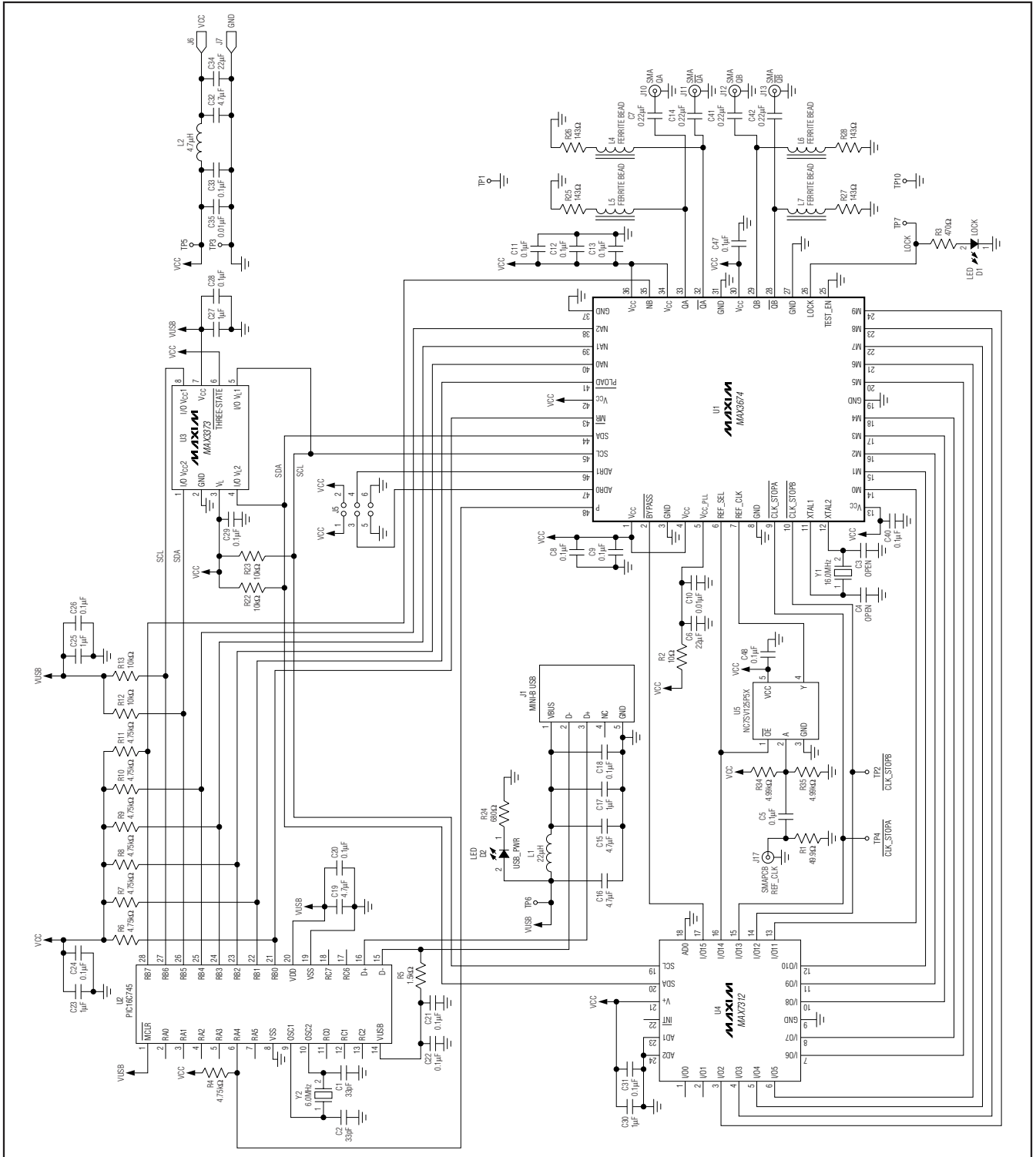

Figure 2. MAX3674 EV Kit Schematic

# MAX3674 Evaluation Kit

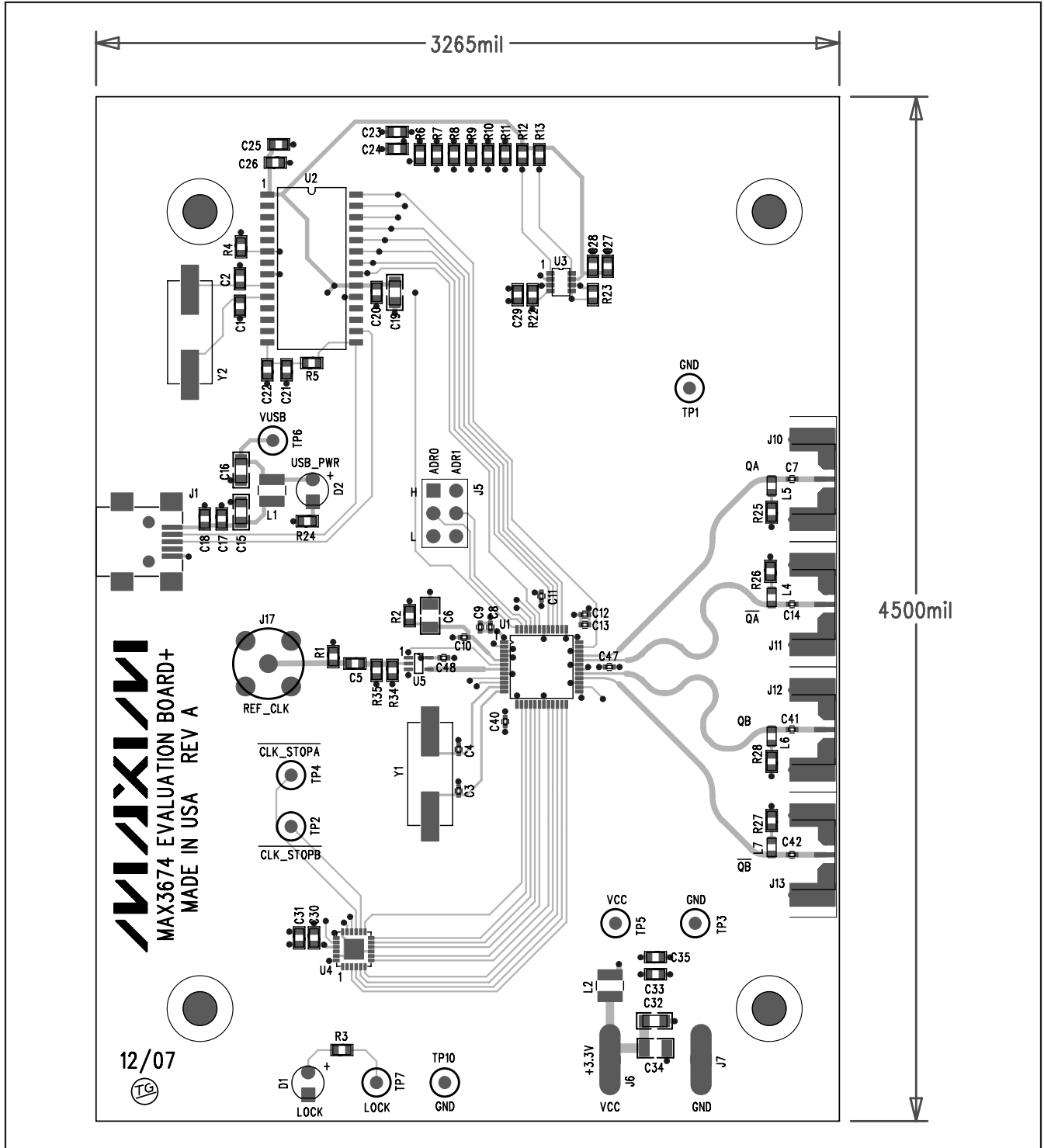

Figure 3. MAX3674 EV Kit Component Placement Guide—Component Side

# MAX3674 Evaluation Kit

Evaluates: MAX3674

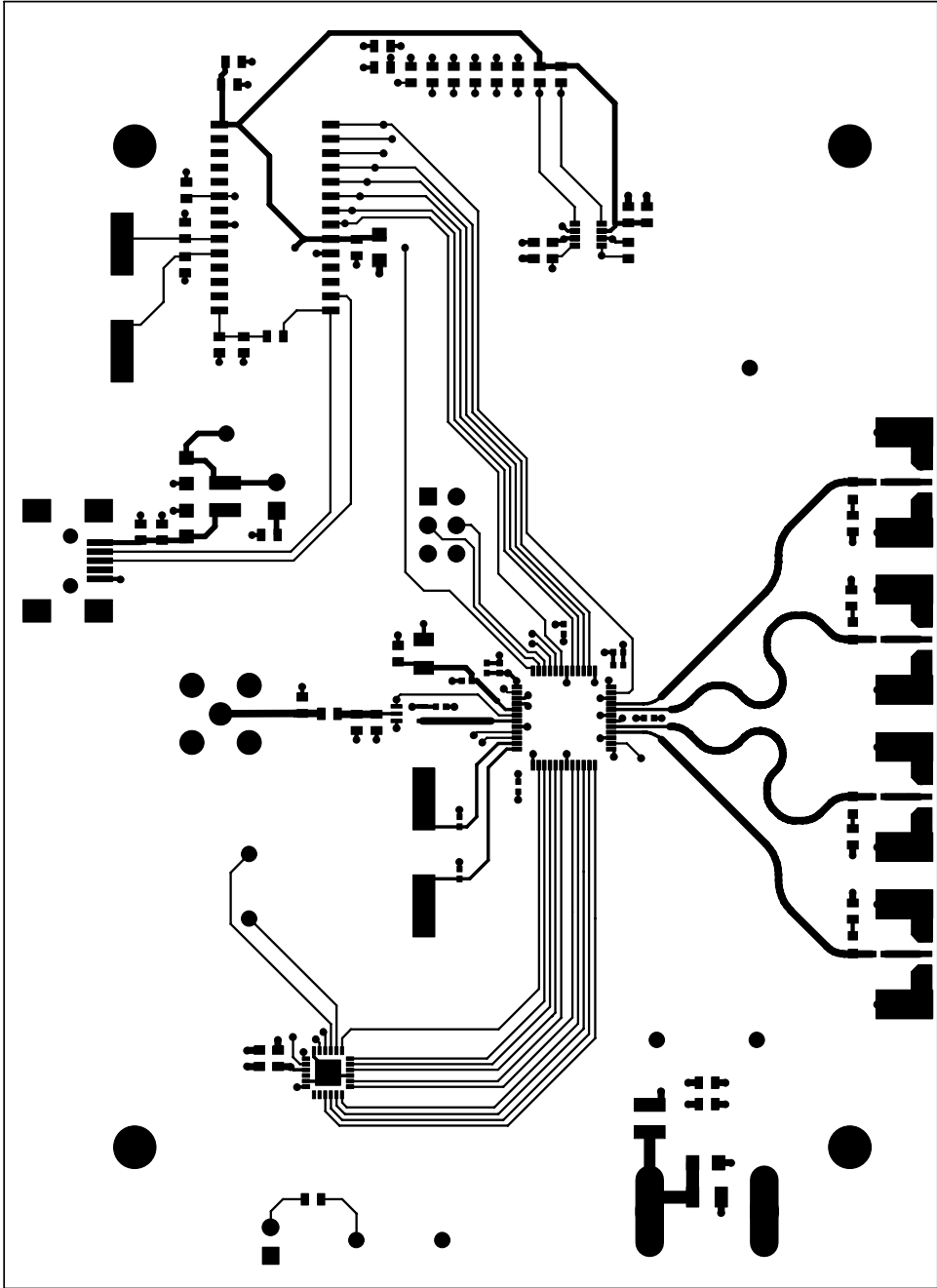

Figure 4. MAX3674 EV Kit PCB Layout—Component Side

# MAX3674 Evaluation Kit

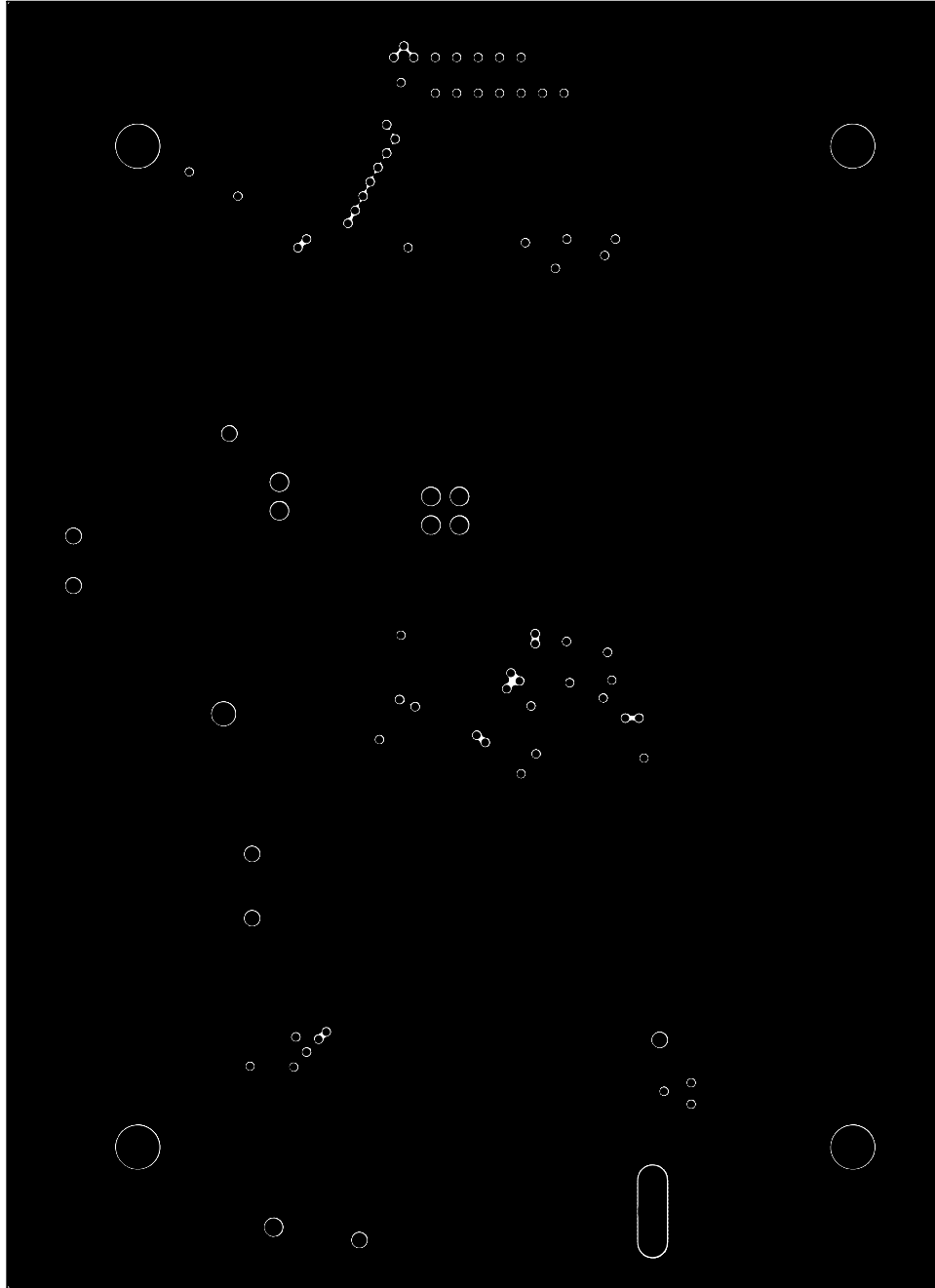

Figure 5. MAX3674 EV Kit PCB Layout—Ground Plane



# MAX3674 Evaluation Kit

Evaluates: MAX3674

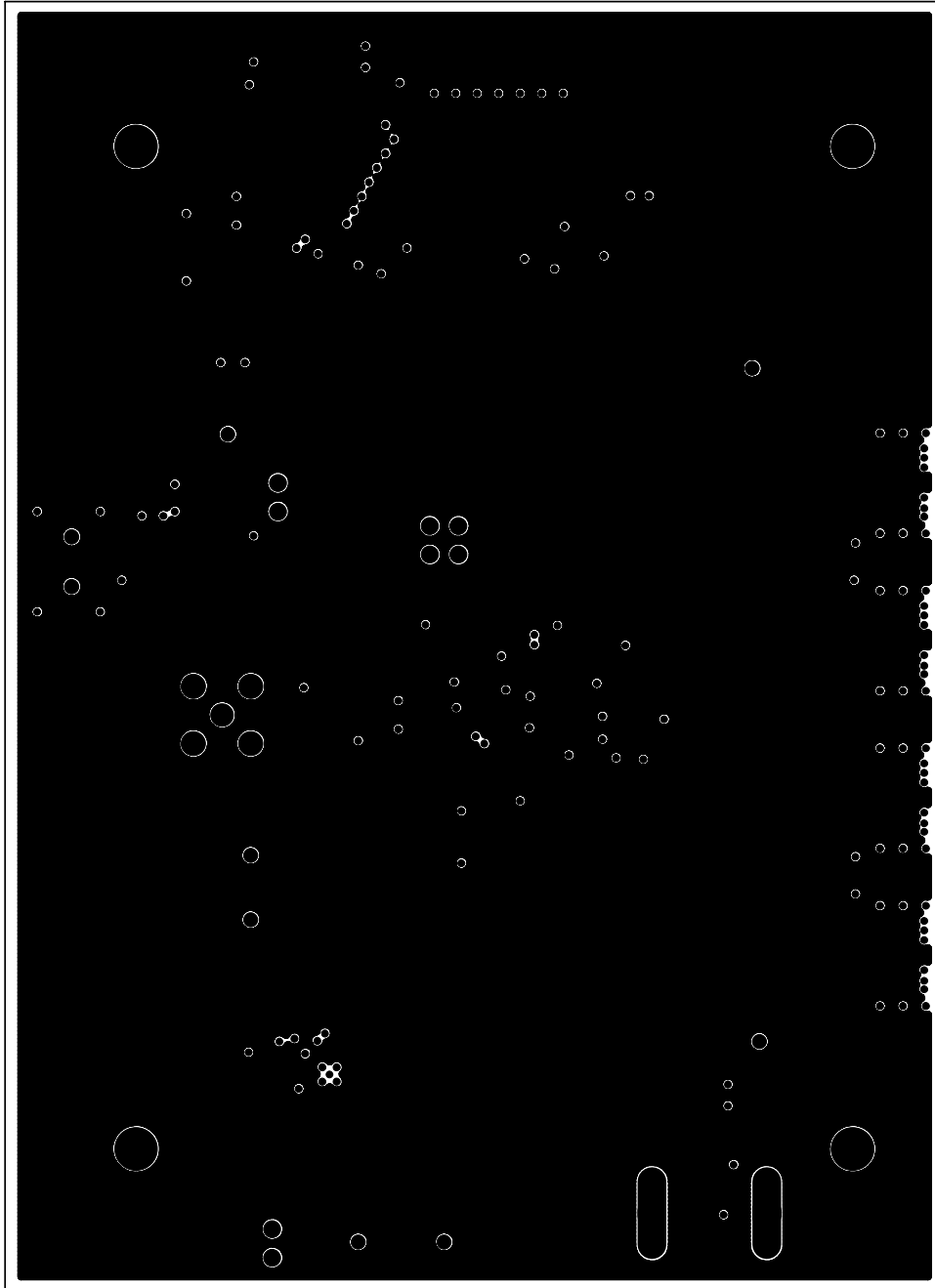

Figure 6. MAX3674 EV Kit PCB Layout—Power Plane

# MAX3674 Evaluation Kit

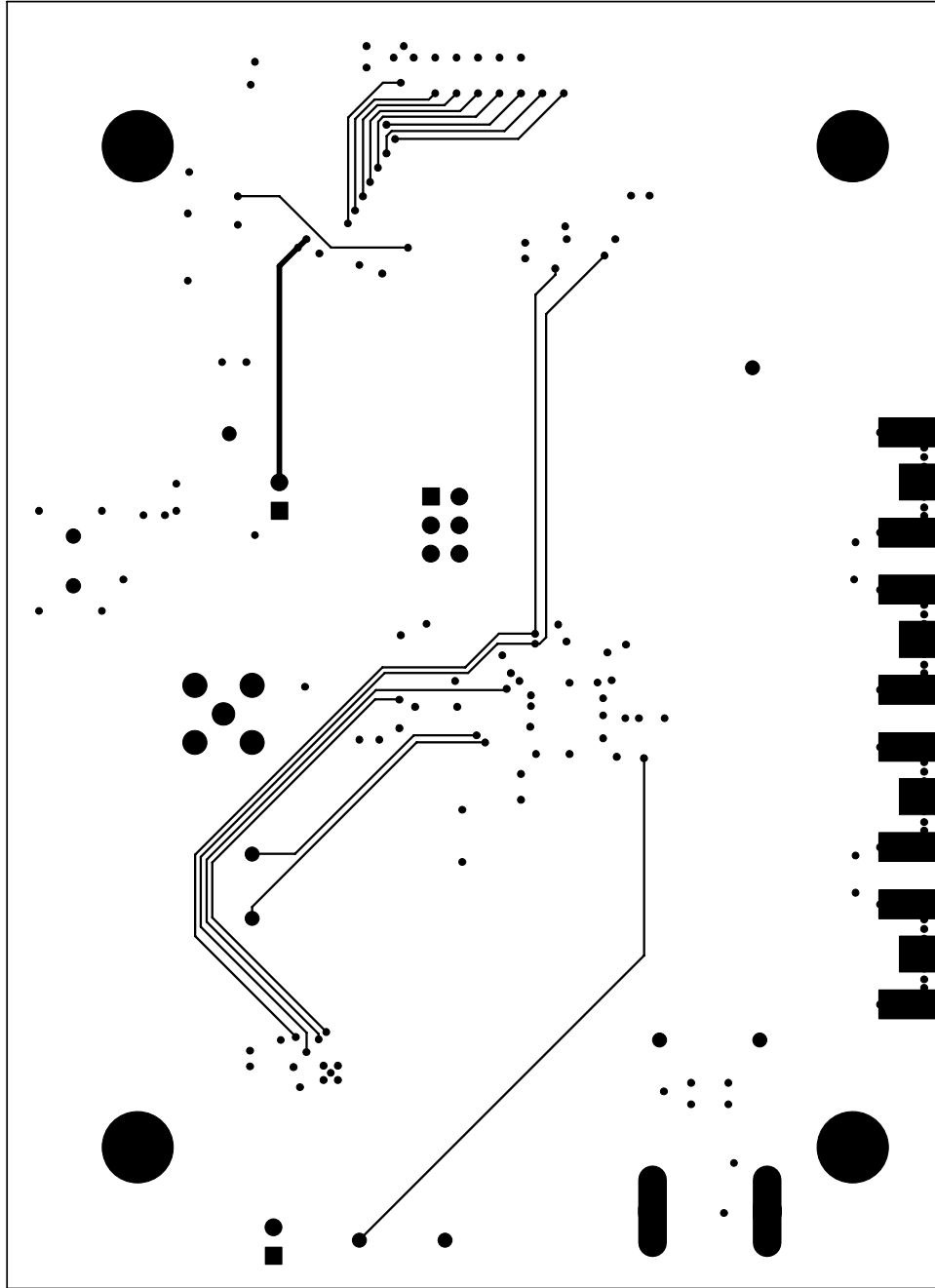

Figure 7. MAX3674 EV Kit PCB Layout—Solder Side

Maxim cannot assume responsibility for use of any circuitry other than circuitry entirely embodied in a Maxim product. No circuit patent licenses are implied. Maxim reserves the right to change the circuitry and specifications without notice at any time.

10 \_\_\_\_\_ **Maxim Integrated Products, 120 San Gabriel Drive, Sunnyvale, CA 94086 408-737-7600**